

Features

- Programmable output voltage to 20 volts
- Sink current capability of 1.0mA to 100mA
- Low dynamic impedance 0.15Ω typical
- Temperature compensated for operation over full rated operating temperature
- Equivalent full-range temperature coefficient of 50ppm/°C (Typical)
- Low output Noise voltage

Ordering Information

Type NO.	Marking	Package Code
A431xM	A431□	TO-92M

□: Grade => B : ±0.5% , A : ±1%

Outline Dimensions

unit : mm

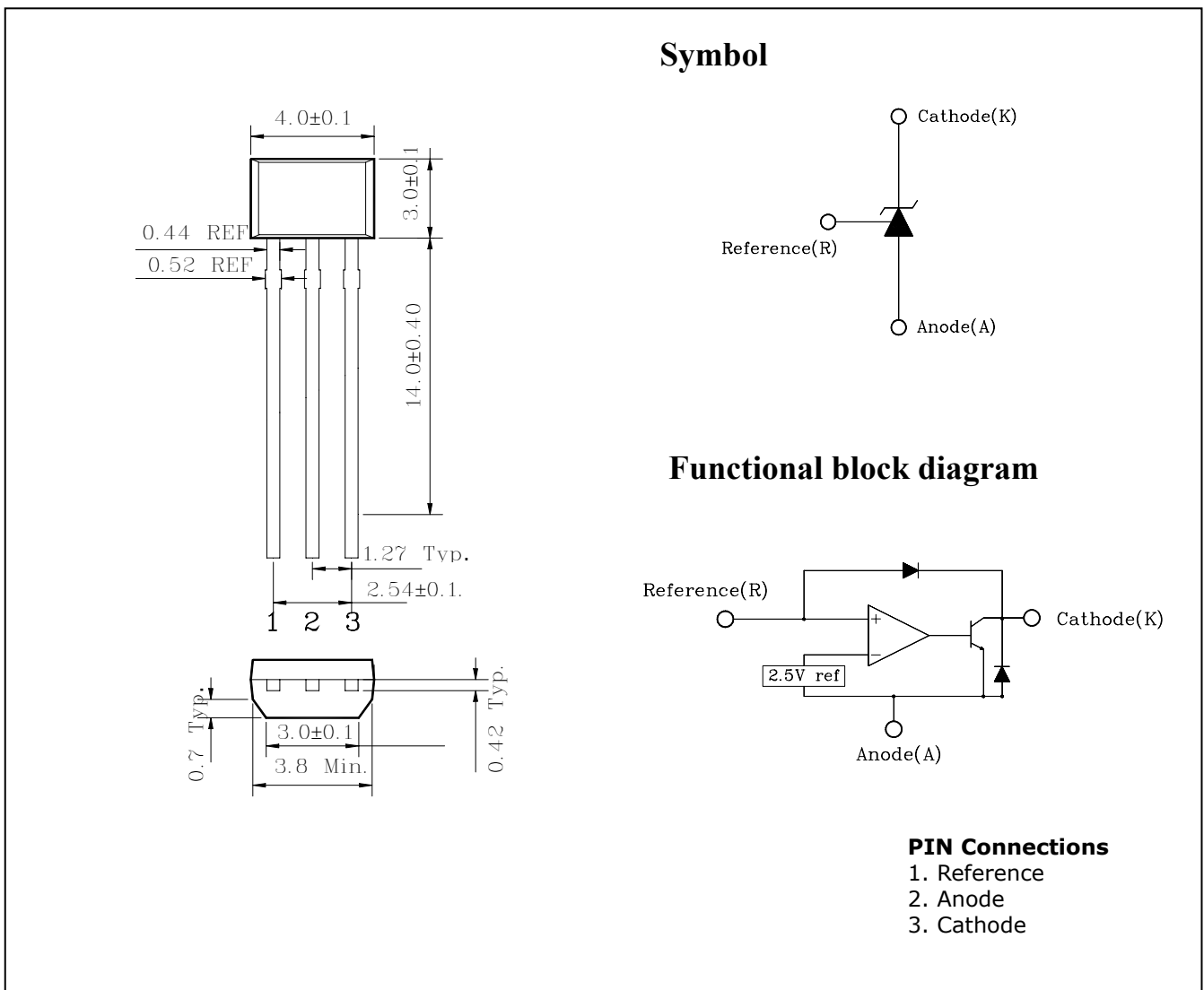

Absolute maximum ratings

(Operating ambient temperature range applies unless other specified)

Parameter	Symbol	Ratings	Unit
Cathode to Anode voltage	V_{KA}	20	V
Cathode current range	I_{KA}	-100 ~ +150	mA
Reference input current range	I_{ref}	-0.05 ~ +10	mA
Power dissipation	P_D	500	mW
Operating temperature range	T_{opr}	-40 ~ +85	°C
Storage temperature range	T_{stg}	-65 ~ +150	°C

Recommended operating conditions

Parameter	Symbol	Ratings		Unit
		Min.	Max.	
Cathode to Anode voltage	V_{KA}	V_{ref}	18	V
Cathode current range	I_{KA}	1.0	100	mA

Electrical Characteristics

(Ambient temperature at 25°C, unless otherwise noted.)

Parameter	Symbol	Condition	Min.	Typ.	Max.	Unit
Reference input voltage (Fig. 1, Note 1)	V_{ref}	$V_{KA}=V_{ref}$, $I_{KA}=10mA$	A431BM 2.482 A431AM 2.470	2.495	2.508 2.520	V
Deviation of reference input voltage Over temperature(Fig. 1, Note 1,2)	ΔV_{ref}	$V_{KA}=V_{ref}$, $I_{KA}=10mA$ @ $T_a=T_{LOW}$ to T_{HIGH}	-	7.0	30	mV
Ratio of change in reference input Voltage to the change in cathode Voltage(Fig. 2)	$\frac{\Delta V_{ref}}{\Delta V_{KA}}$	$I_{KA}=10mA$ $\Delta V_{KA}=10V-V_{ref}$ $\Delta V_{KA}=20V-10V$	-	1.2 0.7	2.7 2.0	mV/V
Reference input current(Fig. 2)	I_{ref}	$I_{KA}=10mA$ $R1=10K\Omega$, $R2=\infty$	-	1.8	4.0	μA
Deviation of reference input current over temperature(Fig. 2)	ΔI_{ref}	$I_{KA}=10mA$ $R1=10K\Omega$, $R2=\infty$	-	0.4	2.5	μA
Minimum cathode current for Regulation(Fig. 1)	I_{MIN}	$V_{KA}=V_{ref}$	-	0.35	1.0	mA
Off-state cathode current(Fig. 3)	I_{OFF}	$V_{KA}=20V$, $V_{ref}=0V$	-	2.7	1000	nA
Dynamic impedance(Fig. 1, Note 3)	Z_{KA}	$V_{KA}=V_{ref}$, $f \leq 1.0KHz$ $I_{KA}=1.0mA-100mA$	-	0.14	0.5	Ω

Fig. 1

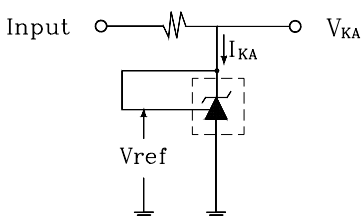

Fig. 2

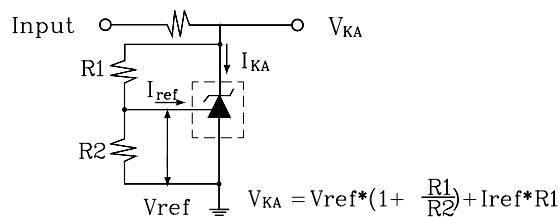
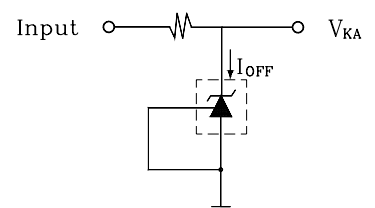

Fig. 3



<Note 1> : $T_{LOW}=-40^{\circ}C$, $T_{HIGH}=+85^{\circ}C$, <Note 2> : $\Delta V_{ref}=V_{ref} Max. - V_{ref} Min.$, <Note 3> : $Z_{KA}=\Delta V_{KA}/\Delta I_{KA}$

Characteristic diagrams

Fig. 4 I_{KA} vs. V_{KA}

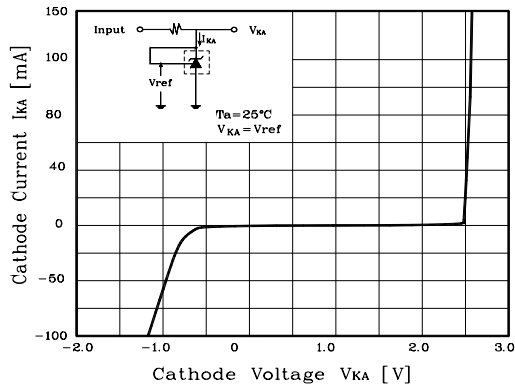

Fig. 5 I_{MIN} vs. V_{KA}

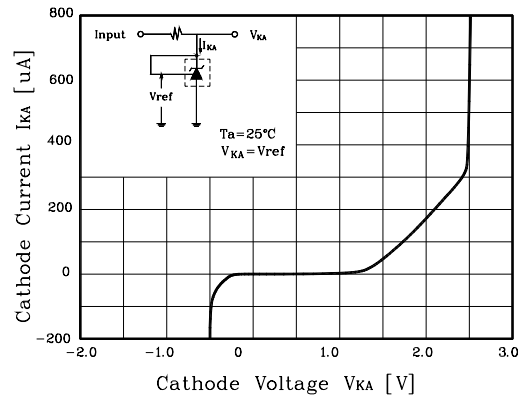

Fig. 6 ΔV_{ref} vs. T_a

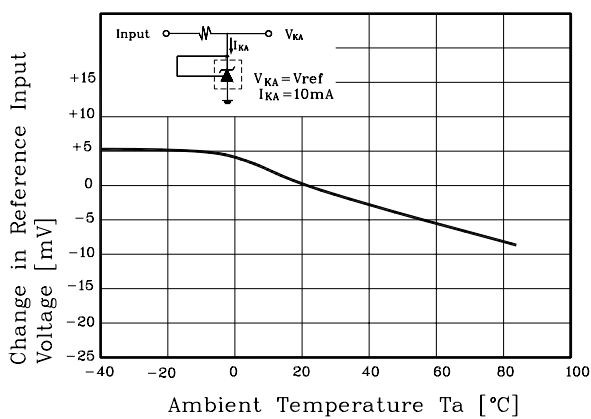

Fig. 7 G_v vs. frequency

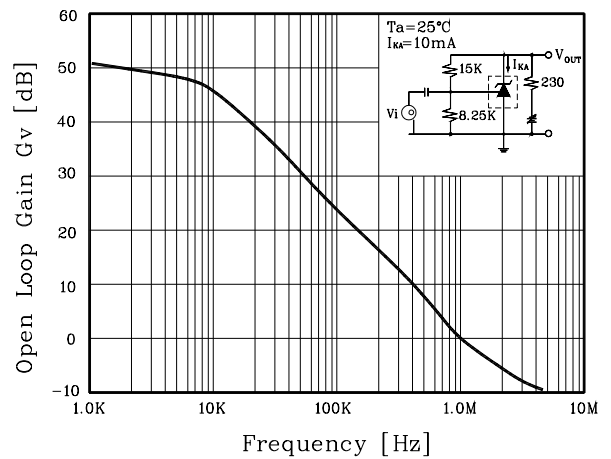
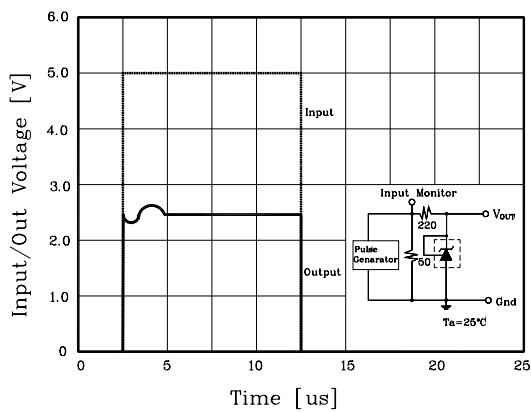

Fig. 8 Pulse response



These AUK products are intended for usage in general electronic equipments(Office and communication equipment, measuring equipment, domestic electrification, etc.).

Please make sure that you consult with us before you use these AUK products in equipments which require high quality and/or reliability, and in equipments which could have major impact to the welfare of human life(atomic energy control, airplane, spaceship, traffic signal, combustion central, all types of safety device, etc.).

AUK cannot accept liability to any damage which may occur in case these AUK products were used in the mentioned equipments without prior consultation with AUK.